

# Study of BLDC Motor Controller Using Arduino-Uno

Anjum ATadmod<sup>1</sup>, Snehal Pandkar<sup>2</sup>, Prof.A.K.Talele<sup>3</sup>, Prof.S.G.Lambor<sup>4</sup>

B.E. Student, Department of Electronics Engineering, Vishwakarma Institute of Technology, Pune, India<sup>1</sup>

B.E. Student, Department of Electronics Engineering, Vishwakarma Institute of Technology, Pune, India<sup>2</sup>

Professor, Department of Electronics Engineering, Vishwakarma Institute of Technology, Pune, India<sup>3</sup>

Professor, Department of Electronics Engineering, Vishwakarma Institute of Technology, Pune, India<sup>4</sup>

**ABSTRACT:**The key feature of BLDC motor is high Torque to weight ratio. Brushless direct current (BLDC) motor is widely used in small and medium sized electric vehicles as it exhibit highest specific power and thermal efficiency as compared to the induction motor. The paper gives an idea of how to control a BLDC of up to 250 Watt efficiently without electronic speed controlling unit. Instead PWM signals are used to control the speed of the motor. Such type of motors are used in electric vehicles which are the future of automobile industry.The motto of this study is to build an efficient yet a low cost BLDC controller.

**KEYWORDS:**Arduino ,Brushless DC (BLDC) motor , H-Bridge, Hub motor.

## I. INTRODUCTION

Brushless DC motor ( BLDC motors) are also known as synchronous DC motors or electronically commutated motors(ECM). They are powered by DC electricity via an inverter or switching power supply which produces an AC electric current to drive each phase of the motor via a closed loop controller

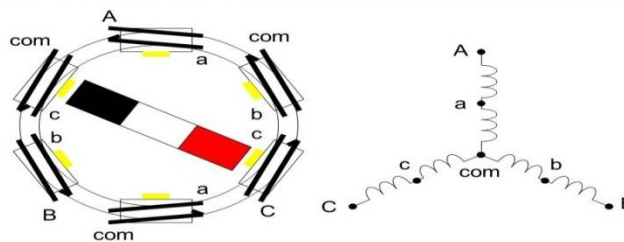

Figure 1

Reduced size and cost, increased torque current ratio, reduced torque ripples, low noises, high efficiency, reduced maintenance and good control characteristics over a wide range in torque speed plane are the various peculiarities of a permanent magnet excited BLDC motor[2]. AC fans using shaded pole or universal motors are bulkier than the BLDC which are smaller in size and weight. The BLDC motors can work with low voltage sources such as 12V DC supply which makes them convenient for use in electronic gadgets like computers, mobiles, spindle drivers for disc memory, because of its high reliability. The speed of the BLDC motor can be controlled by varying the duty cycle. Two key performance parameters of brushless DC motors are the motor constants  $K_T$  (torque constant) and  $K_e$  (back-EMF constant also known as speed constant  $K_V = 1/K_e$  ). In SI units  $K_T$  and  $K_V$  are the same constant:

# International Journal of Innovative Research in Science, Engineering and Technology

(A High Impact Factor, Monthly, Peer Reviewed Journal)

Visit: [www.ijirset.com](http://www.ijirset.com)

Vol. 6, Issue 12, December 2017

$$K_t = \frac{\text{NewtonMeter}}{\text{Amp}}$$

$$K_e = \frac{\text{VoltSecond}}{\text{Radian}}$$

## II. RELATED WORK

The brushless DC motor is one of the most efficient motor nowadays. The motor is used in the applications like [3]:

- Consumer electronics
- Transport
- Heating and ventilation
- Industrial engineering
- Model engineering.

Hence it becomes the need of the hours to design a BLDC motor effectively with low cost and less circuitry.

Most of the research papers have included the Electronic Speed control unit to control the speed of the motor.

ESCs are often used on motors essentially providing an electronically-generated three-phase electric power low voltage source of energy for the motor. It also allows much smoother and more precise variation of motor speed in a far more efficient manner than the mechanical type with a resistive coil and moving arm once in common use[4]. In this study we are designing a BLDC controller without ESC that works with the controlling element i.e Arduino, the MOS drivers and the MOSFET commutation circuitry. With the help of these circuit efficient rotation is not yet achieved but current chopping can help for the smooth functioning of the motor.

## III. PROPOSED METHODOLOGY

The Brushless DC motor is efficient and precise as it a closed loop system. The flow of design of the project as shown in the Figure 2

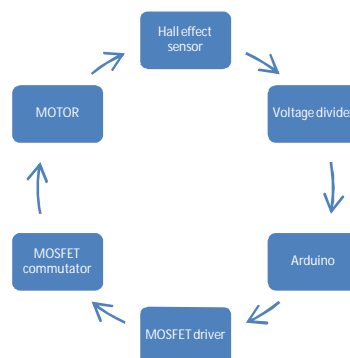

Figure 2

### Output of Hall Effect Sensor:

We are using a sensed BLDC motor which requires a 12V supply for its sensor. The Hall Effect sensor's output is active-low i.e. it gives -12V when it is active and 0 when low. The output of Hall Effect sensor is fed to the controller (which is a digital circuit) for triggering of MOSFET circuitry. Although the negative output obtained from the Hall Effect sensor is not compatible with Arduino. Hence to make it compatible with it a voltage divider circuitry is used in Figure 3

# International Journal of Innovative Research in Science, Engineering and Technology

(A High Impact Factor, Monthly, Peer Reviewed Journal)

Visit: [www.ijirset.com](http://www.ijirset.com)

Vol. 6, Issue 12, December 2017

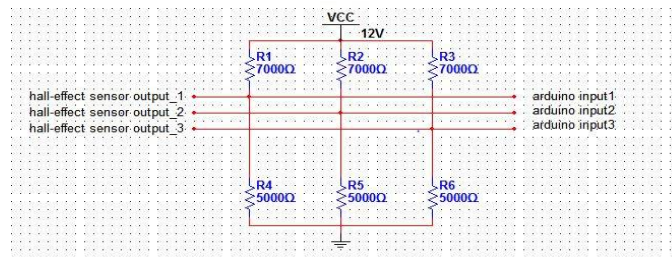

Figure 3

The design of this voltage divider is such that its output is either 0 or 5 volts. This helps to the signals from the hall effect sensor compatible with the Arduino board.

### Speed control using PWM:

The speed of the motor is controlled with a series of “ON-OFF” pulses and varying the duty cycle, the fraction of the time that the output voltage is “ON” compared to when it is “OFF”, of the pulses while keeping the frequency constant.[1] The variation in the output voltage is as shown in the Figure 4

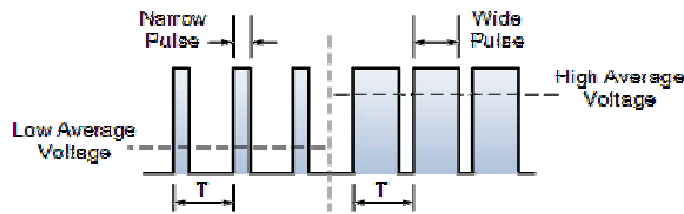

Figure 4

$$V_{avg} = D * V_{input}$$

Where,

D = Duty cycle

Vavg = Average output voltage

Vinput= Input DC voltage

### Algorithm for coding Arduino Board:

The output of voltage divider is given to digital pins (except the PWM digital pins as they are to be used as digital outputs) of Arduino. The Table 1 shows the triggering of the Gate pin of MOSFET in the commutation circuit.

Table 1

Sr.no	Hall Effect sensors			Gate triggering					
	Sensor Y	Sensor B	Sensor C	Drive Q1	Drive Q2	Drive Q3	Drive Q4	Drive Q5	Drive Q6
1	0	1	1	0	1	0	1	0	0
2	0	0	1	0	1	0	0	0	1
3	1	0	1	1	0	0	0	0	1
4	0	1	0	1	0	0	0	1	0
5	1	1	0	0	0	1	0	1	0
6	1	0	0	0	0	1	1	0	0

## International Journal of Innovative Research in Science, Engineering and Technology

(A High Impact Factor, Monthly, Peer Reviewed Journal)

Visit: [www.ijirset.com](http://www.ijirset.com)

Vol. 6, Issue 12, December 2017

The logic of the code is built such that the position of the rotor is sensed. The obtained condition is checked within the code and respective Gates are triggered. The PWM digital pins of the Arduino board are used to control the speed of the BLDC motor, which is done by varying the voltage as per the throttle opening. The purpose of using PWM for the speed control is that sometimes conditions occur that the motor may stall due to the loss of torque. This is why it is considered a highly inefficient circuit and the main reason why PWM control is used in the industry standard.

### .Motor Driver circuit:

The TC4469 devices are a family of four-output CMOS buffers/MOSFET drivers .They has a drive capability of 1.2A peak. Unlike other MOSFET drivers, these devices have two inputs for each output. The inputs are configured as logic gates and AND/INV (TC4469). /TC4469 drivers can continuously source up to 250 mA into ground referenced loads. These devices are ideal for direct driving low current motors or driving MOSFETs in a H-bridge configuration The Figure 5 shows the circuit diagram of the connections of the MOS driver TC 4469 with the MOSFET circuit (i.e commutation circuit). The two input pins of the driver correspond to the single output pin of the IC. One of the input pin is obtained from the Vcc and Ground depending upon NMOS and PMOS respectively. The second input is obtained from the Arduino.

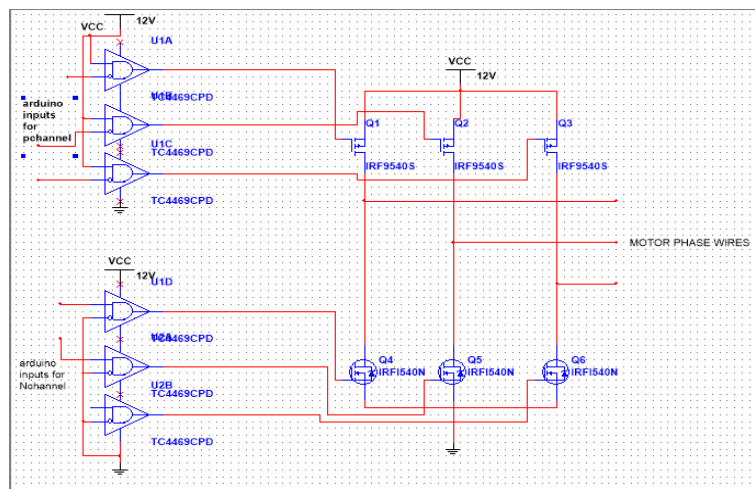

Figure 5

### Mosfet Commutation Circuitry:

An H bridge is an electronic circuit. It enables a voltage to be applied across a load in opposite direction. Such circuits are often used in robotics and other applications to allow DC motors to run forwards or backwards. The Figure 5 shows the combination of p-channel and n-channel is used in which the p-channel MOSFETs are connected to the high voltage bus and n-channel bus to the low voltage bus. The disadvantage of all n-channel is that it leads to complex circuitry. In the BLDC motor as only two phases are activated at one instant and the third phase is kept neutral. To trigger the respective phase Table 1 is taken into consideration. The gates are triggered such that the respective phase is energized and the motor rotates. The Figure 6 shows the actual circuit connection of the MOSFET commutation circuitry and its driver TC4469.

# International Journal of Innovative Research in Science, Engineering and Technology

(A High Impact Factor, Monthly, Peer Reviewed Journal)

Visit: [www.ijirset.com](http://www.ijirset.com)

Vol. 6, Issue 12, December 2017

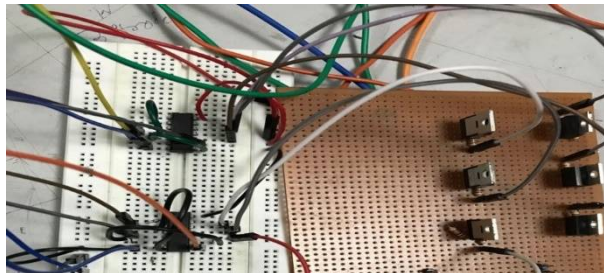

Figure 6

## IV. PERFORMANCE AND EXPERIMENTS

- The output of the hall effect sensors are as shown in the Figure 7.

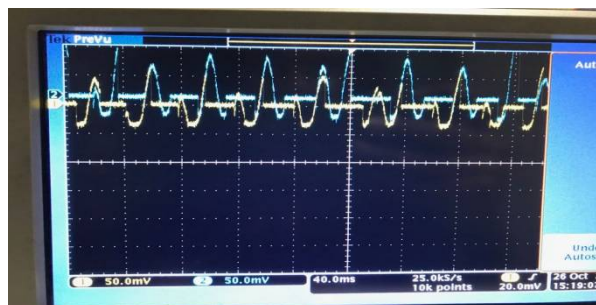

Figure 7

- The Figure 8 shows the BLDC hub motor used for the reference of study.



Figure 8

## V. CONCLUSION

From the study of BLDC motor controller using Arduino it can be concluded that the smooth functioning of the motor requires appropriate chopping of the current.

## REFERENCES

1. Kusko, A. &Peeran, S. M. (1987) Brushless DC motor using asymmetrical field magnetization. IEEE Transactions on Industrial Applications, 23 (2):319 Bolton, H. R. & Ashen R.A. (1984)
2. Influence of motor design and feed current Imperial Journal of Interdisciplinary Research (IJIR).
3. <https://www.elprocus.com/brushless-dc-motor-advantages-applications-and-control/>
4. [http://erlerobotics.com/blog/product/electronic\\_speed\\_controller/](http://erlerobotics.com/blog/product/electronic_speed_controller/)



ISSN(Online): 2319-8753  
ISSN (Print): 2347-6710

## International Journal of Innovative Research in Science, Engineering and Technology

*(A High Impact Factor, Monthly, Peer Reviewed Journal)*

Visit: [www.ijirset.com](http://www.ijirset.com)

**Vol. 6, Issue 12, December 2017**

5. Author:Ward Brown ,Microchip Technology Inc. Brushless DC Motor Control using the LPC2141 Application Note; AN10661, NXP Semiconductors: Eindhoven, the Netherlands, October 2007.
6. Brushless DC (BLDC) Motor Fundamentals Application Note; AN885, Microchip: AZ, USA. 2003.
7. Burger, F.; Besse, P.A.; Popovic, R.S. New Single Chip Hall Sensor for Three Phases Brushless Motor Control. Sens. Actuat. A-Phys. 2000, 81, 320-323.
8. 3-Phase BLDC Motor Control with Hall Sensors using 56000/E Digital Signal Controllers Application Note; AN1916, Freescale Semiconductor: TX, USA, 2005.
9. AnandSathyanPh.D Thesis —Digital PWM Control of Brush Less DC (BLDC) Motor Drives, Illinois Institute of Technology, Chicago, Illinois, December 2008.
10. A.Tashakori, M. Ektesabi, "Comparison of Different PWM Switching Modes of BLDC Motor as Drive Train of Electric Vehicles", World Academy of Science, Engineering and Technology, 67, 2012.
11. Ruta A. Bhave, Mitali S. Gogate, Ajay A. Maity, Priyanka D. Shivthare, "Wireless Automation of an Electrical Drive using Bluetooth", IJESRT, vol.2, issue 11, pp. 3291-3294, Nov. 2013.